

KELLY COMMUNIQUE

VOLUME 34

THE BRIDAL ISSUE

MAY/JUNE 1995



ENGINEERING TECHNOBABLE

Executive Officer Lt. Cmdr. Amy J. Wullschleger

Well, here we are, almost halfway through the New Year. Can you believe there are only 239 days until Christmas??? Then it's "Hello Santa!!!"

As you will probably guess as you browse through this issue of the Communique, the Engineering Department has done their best to bring smiles and laughter to each and every one of you. Since May and June are traditionally the most popular months for Terran weddings, we have decided to make this the Bridal Issue. There are a few articles in this issue that can help you on your way to wedded bliss. And for those of you not readily pursuing poetry and hurling things through the air, well...save it for future reference.

In the next few pages you will see a variety of articles, pictures and general...STUFF!! I hope you enjoy it all. I am also going to enlighten you on the April Kelly activity just a bit, a fun time was had by all...if you don't believe me refer to an upcoming article by Lt.Cmdr. Carl K. Stark for an in depth view on some of the wonderful things that happened on our "away mission."

Robert Picardo, the doctor on Voyager and Jonathan Frakes, William T. Riker on St:TNG and various other Star Trek shows, were the guests. Both were the embodiment of absolute entertainment, from Robert Picardo's quips about the "other bald men" of Star Trek to Jonathan's opening lyrics of "VOLARE" it was a constant rollercoaster of fun. I enjoyed them both immensely.

I think perhaps my favorite part of Robert Picardo's talk happened when he misunderstood one young man at the microphone. The boy asked "What would you think of a 4th grade script writer?" and Robert stood there for a few moments as if he was pondering his answer, then came to say "Did you say What would I think of a fourth rate shrimp grinder?" The entire audience fell off their chairs laughing. He was a great guest and I hope to see him again soon. He was also very generous with his time in signing autographs...the second day he promised EVERYONE would get an autograph, and to my knowledge everyone did.

Jonathan Frakes was a total wonder. He came out on stage singing the opening phrase of "Volare" (oh..oh, Contade'...oh oh oh oh)...the audience got a huge kick out of this..each and every time he did it..and believe me, Jonathan will break into many a song when the mood takes him. The mood took him many a time on Sunday. I personally enjoyed him calling a radio station, from the stage and letting us all yell and sing...it was kind of like "Live from Denver...it's Jonathan Frakes and 3,000 of his closest friends". I found it funny when he was trying to get through to his D.J. friend and he told the receptionist..."Frakes not Franks.." then "Jonathan Frakes...Brian Frakes' brother." Like no one knew who he was. Anyway, he advised us he would not be doing autographs but would sign anything that was sent to him. The address will be listed in this communique.

I enjoyed this convention far more than any convention I have been to in quite awhile...let us hope that many more Kelly members will attend in September to see Kate Mulgrew...the best darned female Captain in the Fleet.

Lwaxana's Love Balls
A Betazoid Aphrodesiac

Makes 12 balls

Ingredients:

- 5 oz. condensed milk
- 1/4 cup butter
- 1/4 cup grated coconut
- 1/4 cup cocoa
- 2 tbsp sugar
- 15 to 20 digestive biscuits, crumbled
- 1 tsp rum extract
- 1 cup grated chocolate

- **In a saucepan heat milk, add butter and stir
- **Stir in grated coconut, cocoa and sugar
- **Add crumbled biscuits and stir until mixture thickens
- **Stir in rum extract
- **Refrigerate 1 hour
- **Shape into small balls and roll in grated chocolate

These wonderful Betazed morsels are just the thing for any Honeymoon Fare; they add to any honeymoon mood quite nicely. I also highly recommend them to women trying to catch her husband-to-be. One bite and even a shapeshifter won't be able to resist you. These tasty tidbits are also wonderful for any Wedding Party, but be forewarned...they can make things a bit dangerous for wedding guests. Just be prepared with buckets of cold water, for those who get out of control. These little bites of heaven can be just the thing to rid yourself of those awful little inhibitions...just ask Lwaxana!!

JONATHAN FRAKES

(*Riker*) **What he's doing:** Directed episodes of *Deep Space Nine*, *Voyager*, and *University Hospital*. Does the voice of the villain Xanatos on *Gargoyles*. **What's Riker doing now?** "I wish the show had gone on. It wouldn't have mattered what Riker was up to. I mean, why did we stop?"



JOHN DE LANGIE (Q)

What he's doing: Co-starring in UPN's *Legend*. **What's Q doing now?** "I have no idea. At conventions, people always ask me questions like 'If Q met Godzilla, who'd win?' It's kind of like 'If my aunt had balls, would she be my uncle?' I don't answer 'if' questions."



DO NOT FORGET THE KELLY AUCTION!!!

You can still turn in items to be put up for bid.



PATRICK STEWART (Picard) **What he's doing:** Recently finished filming the features *Jefrey*, a gay love story to be released in August, and *Let It Be Me*,

a romantic comedy about ballroom dancing. Also preparing to film *The Canterville Ghost*, an ABC-TV movie for next season. **What's Picard doing now?** "Jean-Luc Picard is a fictional character. He does not have an independent existence."

CONVENTION REPORT ON KELLY ACTIVATES AT STARFEST'95-

LT. COMMANDER CARL STARK (aka ~~DCR~~ ~~BUTT!~~) REPORTING.

STARDATE: 48040.7 TO 48041.0

Well I'm writing this on the way home from Denver, Colorado. The ion (snow) storm is continuing to hamper our efforts. However we are continuing forward at best speeds for the homeport. I'm really impressed with how my shuttle has held over the long haul. The convention was one of the better cons that StarLand has held in quite a while. It had it's ups and downs however there was more good things that happened this year.

Friday saw the majority of crewmembers leave Salt Lake at 5:30am and make very good time to Denver. The trip over I-80 took just under 9 hours. With 12 crewmembers in four vehicles the trip was very comfortable and without any incident. After arriving around 3:00pm we rendezvous with other crewmembers who did not have the endurance for the overland trip.

The majority of the convention on Friday was spent visiting the dealers room, participating in the holodeck, entering models and miniatures in the modeling contest. And since the theme of this years StarFest'95 was James Bond we participated in various activities including finding clue cards for prizes and playing at the Casino Royale. Unfortunately there wasn't a midnight movie this year. Correspondence members Ensign Rob Russell and his wife Teresa came by to show of there new baby girl named Kes. After all of this there was the dunk the Captain contest in the pool. Friday's uniform was the new Kelly T-shirts. These brought a lot of attention to the various crewmembers who then informed the inquiring person that the Kelly model was on display in the activities room.

Saturday the convention continued with volunteers to participate in the Voyager, Deep Space Nine, and Next Generation written trivia tests, the search for more clue cards, saving seats to see Robert Picardo and Jonathan Frakes speeches, saving places in line for Robert Picardo's autograph, and more wandering around the dealers room. We cut short watching the Jonathan Frakes speech to hold our April Kelly meeting in the Holiday Inn resturant. Since the uniform of the day was our regular duty uniform, the dinner was just like having a meal in the Captain's private dining room. Orders and rank advancements were given out including the Cosmic Cowboy (TD Boone) receiving his Lt. Commander. If you would like to congratulate him just ask him to sing for you. We held the dinner meeting early so that we could get back to the main events room to see the comedy play Star Trek: Degenerations. After which was the costume contest. We all had a chance to support Lt. Nessa Harvey with her entry (Hello Nurse!) For some of us the evening ended when we went to the hotel bar in uniform (along with a large number of uniformed convention goers) to imagine what it would be like to be in a bar at a Starbase somewhere. Luckily no Nassicans wanted to fight.

Sunday was more laid-back than the other two days. We awoke to lots of snow on the ground which hampered some of the convention goers on there return to the hotel. Most of us had purchased tickets to attend the convention brunch with Dave McDonnell (editor of Starlog magazine) and other guests of the convention. At high noon the competitors gathered to find out who knew more about the Next Generation in the TNG Jeopardy Contest. More searching for cards and items in the dealers room. Those who missed Jonathan and Robert speak on Saturday attended there speeches and those who did not get an autograph the first time attempted to get some as well. That night the majority of crewmembers discovered an excellent Mexican resturant close to the convention hotel. After which some of the crewmembers had to catch

their flights out of Denver's tent covered spaceport.

Monday morning brought more snow. Apparently anything over six inches shuts down the schools and roads in Denver, however being from Utah, we did not encounter any troubles getting out and back on the route to home. The eastern part of Wyoming was bad weather however once past Larime there wasn't any problems what so ever.

The Kelly was very well represented at StarFest'95. Several prizes and awards were taken by various crewmembers. Here are some of the highlights. Captain Dennis Hollinger placed 1st in the Voyager written trivia test and qualified to participate in the Next Generation Jeopardy Trivia Contest. Captain Hollinger also received a perfect score in the Holodeck simulator. Commander Richard Henline qualified to participate in the Next Generation Jeopardy Trivia Contest. Lt. Commander Carl Stark placed 3rd in the Deep Space Nine written trivia test and qualified to participated in the Next Generation Jeopardy Trivia Contest, in which he placed 2nd overall. Lt. Commander Stark also received a perfect score in the Holodeck simulator. Lt. Commander TD Boone entered several items in the modeling and miniatures contest. His model of the USS Kelly took first in the modified model division. The model of the USS Cairo took third in the kit division. And a miniature of a purple dragon took third in its division. Lt. Nessa Harvey took second place in the Masquerade with her Bajoran Joining Dress. Ensign Andy Fisher earned the most credits at the Casino Royale. Ensign Robert Shaffer had a perfect score in the Holodeck Simulator. And everyone took home prizes when hunting for Clue Cards.

QUESTION OF THE MONTH

If you could marry any life form known in The Star Trek Universe what would it be?

Lt. j.g. Glen L. Bogue - A beautiful, young, unsuspecting Star Fleet officer who shall remain nameless.

C/1 Jared Schreiner - A Metamorph, Because I want a want a woman that will conform to my every desire.

Ens. Aaron "Pookey Bear" Bogue - I agree with Jared, for obvious reasons.

C/2 Jill Hyatt - Betazed, it would be nice not to have to tell a man what I want or how I feel.

Lt. Cmdr. Amy J. Wullschleger - Klingon, I kinda like the mating rituals (growlllll).

Lt. Cmdr. Carl K. Stark - An empathic Klingon named K'aleth Ral Nong Yong (for obvious reasons).

Lt. Nessa Harvey - This is a hard question, because there is no life form I would marry. However, I would consider marrying a Bajoran (hard to believe) because the men take a step back from the women. I am very independent, and would rather have a companion than someone to take care of me. I believe a Bajoran would be there for me, but not try to run my life, or attempt to make life easier when problems arise. Marriage needs to be a group effort, and Bajoran men are more accepting of strong-minded women, and would allow an equal level of input and support.

MARINA SIRTIS (*Troi*)

What she's doing:

We're still trying to find out. According to her agent's office, Sirtis has no projects currently scheduled.

Also, they say she is taking a "hiatus from her publicist."



Weapons Cluster

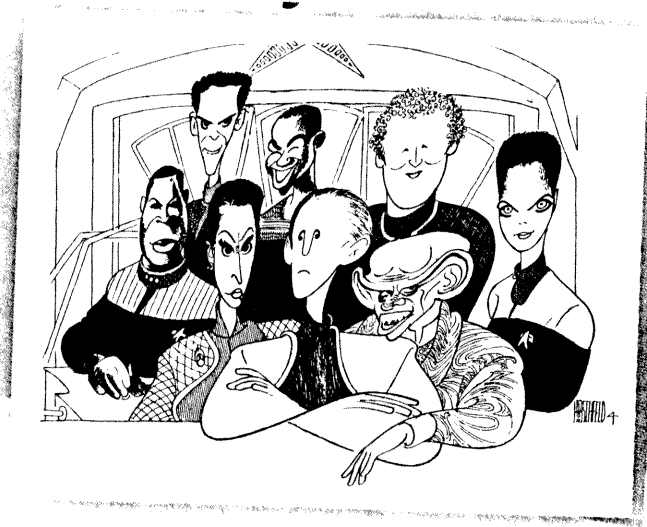

Cloaking Device
Generators

Impulse
Engines

Bridge
Module

Warp Cowling

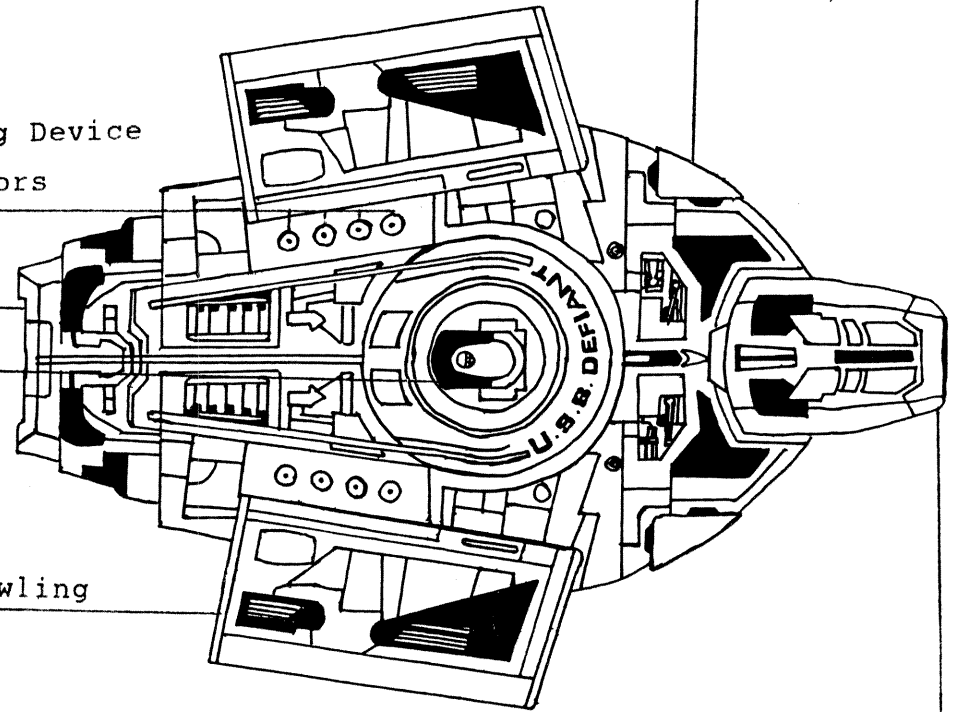

Navigational Deflector

Defiant Class Escort
Prototype
Registry: NX-74205
Current Assingment: DS9

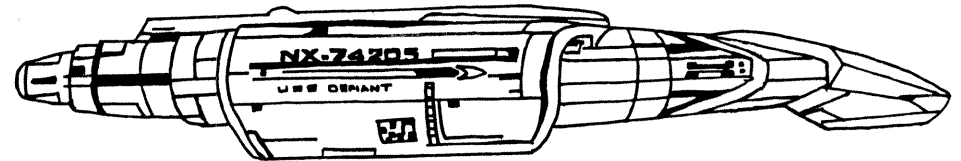

The Defiant class escort was originally designed to face the Borg threat, and uses some Romulan technology, most notably a cloaking device. The Defiant is now assigned to Deep Space 9 to help protect against the new threat of the Dominion, and their Gem Hadar. She also carries an array of experimental weapons, including Quantum Photon Torpedoes, and Triple Redundant Interlocking Phasers, quite a powerful combination. In fact, Defiant was made so powerful that it is said that She almost flew herself appart in her original test runs. All this combined with Her small size (she can fit on top of the blade of a Cardassian Galor class cruiser) make Defiant a force to be reckoned with, and one of the most impressive Ships of the Galaxy.

(Article submitted by T. D. Boone, The Cosmic Cowboy)

GETTING THE SCI-FI CHANNEL ON YOUR CABLE SYSTEM

Here are some suggestions about what can be done to help encourage cable cos. to add the Sci-Fi Channel to your life.

1. **CALL, WRITE OR FAX** the general manager of your cable company and request that the Sci-Fi Channel be added to your system's lineup. you may want to send a copy of the letter to your city council person or city cable administrator.
 2. **START A PETITION.** Get as many signatures as possible from people who want the Sci-Fi Channel on your cable system. Deliver the petition to your cable company.
 3. **START A CALL-IN CAMPAIGN** with your neighbors to your cable company's Director of Marketing.
- WRITE** an editorial and submit it to your local newspapers.
CALL local radio station talk show hosts.

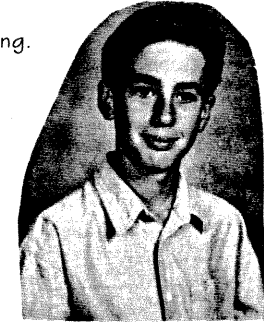

CREW PROFILES FOR THE COMMUNIQUE

NATHAN PERRY

Born in SLC, UT on 8/5/81 and have lived in the same place ever since. I have a close family and see my Grandparents, Aunts & Uncles all the time. I enjoy playing Nintendo, basketball, & football, and of course watching Star Trek. I am a 4.0 student in school (straight A's). I got interested in Star Trek when ST: 5 premiered & became a fan from that time on, and have been a loyal fan ever since. My race in the Star Trek world is 3/4 Vulcan and 1/4 Romulan, but I'm a Vulcan at heart. I act like humans so they will accept me. I am a very good actor. I may give my report to the Vulcan Science Academy on humans. My favorite episode and movie are; Measure of a Man, ST: 2 The Wrath of Khan. My favorite characters are McCoy, LaForge, Quark, Tuvok.

ROBERT M. SHAFFER

Born-Jan. 30, 1972 in Bangkok, Thailand. Was a Military Brat for 19 yrs. My family consists of 1 father, 1 more, 1 stepmom, 2 stepsisters, 1 brother. Occupation- Security officer. Hobbies included collecting items of interest. Talents include short story writing, poetry, I am computer literate, and like creating new ideas. I Developed a Canine Race (The Nachoka) for Star Trek. I got interested in Star Trek because of the technology, there are too many episodes to name that I count as my favorite. I have been a fan for as long as I can remember. I am not sure if there is anything I like least about Star Trek.



My character is Human. Alexander Michael Thomas Hillerman comes from a long line of family members who have been in Starfleet. The timeline starts from 2190 to 2369, to go further back would take up too much time. Alex was born on Earth, in the Western States of North America. There is some Oriental ancestry in his family bloodline. His goal for adventure was to go into space and explore. As an engineer he wanted to redesign warp engines. While going through the Academy, he was fortunate enough to meet Cadet Crusher and learn a few tricks of the trade. His original field of interest was Medical, but after joining Starfleet and studying warp theories he found he was more drawn to engineering. He has cross-trained in the Security division and done very well there. When he received his first assignment to the USS Dominion, he was hesitant and transferred to the USS Romulus. Afterwards he found that the USS Kelly needed more engineers he asked for and got a transfer to that ship. He enjoys making department chief wonder what types of projects he will be working on in the engine room. One of his goals is to be able to discover a more efficient way of compacting the intermix chamber so more space on starships can be used for other things. He hopes that his stay in this current assignment will be a long one. He wants to make chief someday but for the time being is content to work on his theories and simulations.

JOSHUA WILLIAM SANTIAGO

Born in Granger, grew up in Kearns and has been there all life. Lives with his mom, dad, a sister, 2 cats, 1 dog, and fish, one named Picard, another was named Worf, but he died when the water got too hot and boiled him. Star Trek is a major hobby, collecting the figures, ships, tricorder, models, etc. Baseball & basketball as well as Nintendo are favorites. Talents include playing the piano, singing, and acting (was just in a school play). A unique thing about me is that I am always cheerful, caring, and honest. As well as a straight A student in school, which I love.

Character is Klingon/Vulcan. Born on Vulcan, raised on the Klingon homeworld Vulcan, and Earth. My father is Vulcan who gave up the Vulcan ways. He was an ambassador. My mother was a Klingon Commander, she met my father while escorting him. They fell in love (Don't ask me how) and got married. I am serious and logical, but sometimes loose my temper (like a Klingon). I was always interested in ST but got very interested after reading some of the books. My favorite movie are ST 2 & 4. I have been a fan forever. I like the fact there is always something new about ST. What I like least is that they cancelled STTNG.





BRENT SPINER (*Data*)

What he's doing: An international promotional tour for the film *Star Trek Generations*—and yet his publicist says, "Brent

is unavailable [to discuss this], as he is taking a breather from publicity."

QUOTES

"She was draped across my body, but that's not the point." - Lt. Cmdr. Rex Rouviere

"It's so short." "This one's long." - Lt. Nessa Harvey/Cmdr. Nada Henline

"I'm coming, I'm coming. I'm just not coming as quickly as you are." - Lt. Nessa Harvey

"No, you didn't wear me out. . ." - C/2 Cameron Looney, Communications

"It's gone, it's gone!" "Do you want it back?" - Lt. N. Harvey/Lt. j.g. Mark Boone

"Talk to the hand don't drool on the boots." - C/1 Jared Schreiner

"So Amy, what makes the Kelly go?" "Conn." "No, how do you actually make it go?" "Point your fingers like this and say Engage (In an outrageous English/French accent)." - Lt. Cmdr. Amy Wullschleger

"Umax, anyone?" - You Know Who You Are!

MICHAEL DORN (*Worf*)

What he's doing: Recently finished filming *The Timemaster*, a feature to be released in August; and an upcoming Showtime

movie, *Amanda and the Alien*, with Nicole Eggert. **Is there life after *Trek*?**

"Oh, yeah. We have a great following. Once you have that kind of juice behind you, you don't lose that."

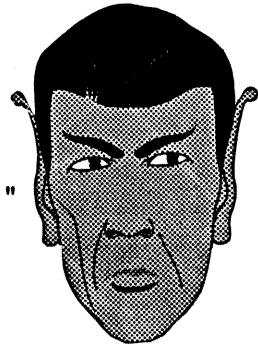

"Ha, ha very funny Scotty, now beam down my clothes!"



Beaming down to Vegas

LAS VEGAS--Thanks to a joint venture between Hilton Hotels Corp. and Paramount Parks, Star Trek is about to beam down to America's gaming capital. The partners have announced plans to build a \$50 million, 50'000-square-foot Star Trek-themed entertainment complex that will become a permanent part of the Las Vegas Hilton. Opening is scheduled for December 1996, the 30th anniversary of the original Star Trek TV series. Star Trek: The Experience will feature interactive video and virtual reality stations, enabling visitors to act as crew members of the legendary starship Enterprise.

The Joining

The Bajoran culture is so misunderstood. During the occupation, so much of what we believed was trampled upon and buried by the Cardassians. But now, in our time of rediscovery, traditions of old are resurfacing once again.

This young woman, as she prepares to join her life with another, must seek to unite her past experiences with her future life. For one day before the joining, each partner spends the time alone. Learning, growing, and accepting what was is, and to become. This is a time of great internal contemplation, as each individual searches their own soul for the truth that lies within.

The candles glowing before you represent the Spirits that will guide the path. As a candle in nothing but wax and wick when touched with energy and air it becomes more than what it was to begin with. This is also the way of the Bajoran Joining.

Each member, too, becomes more than what they were to begin with. This is symbolized by the single candle that they hold during this time.

And at the first light of dawn, they extinguish the flame of their life as it is now, only to re-ignite it as their new lives begin together at the altar with their chosen mate.

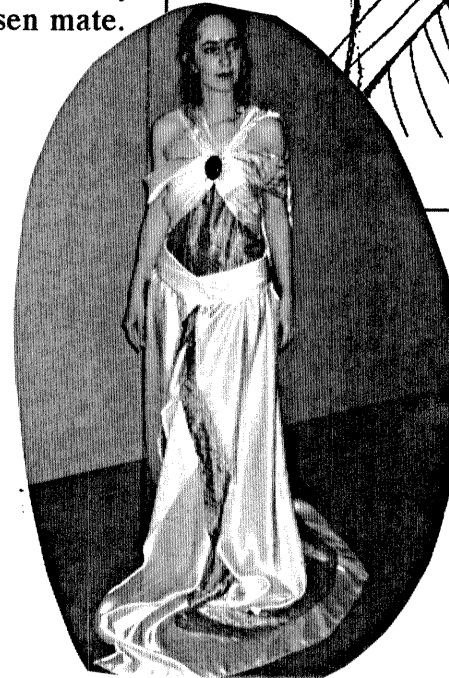
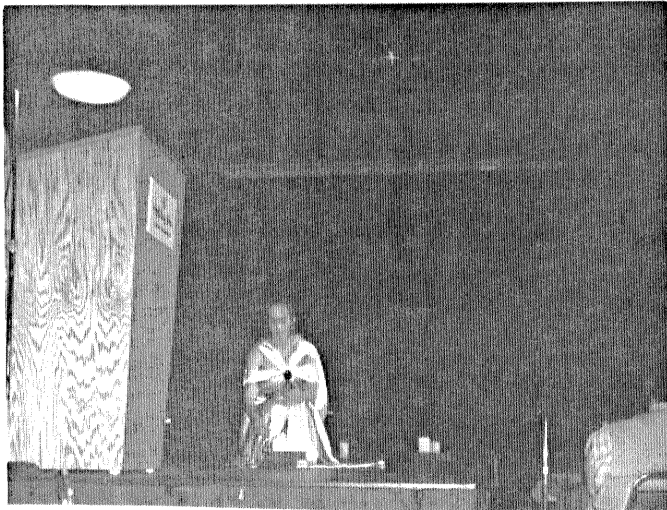
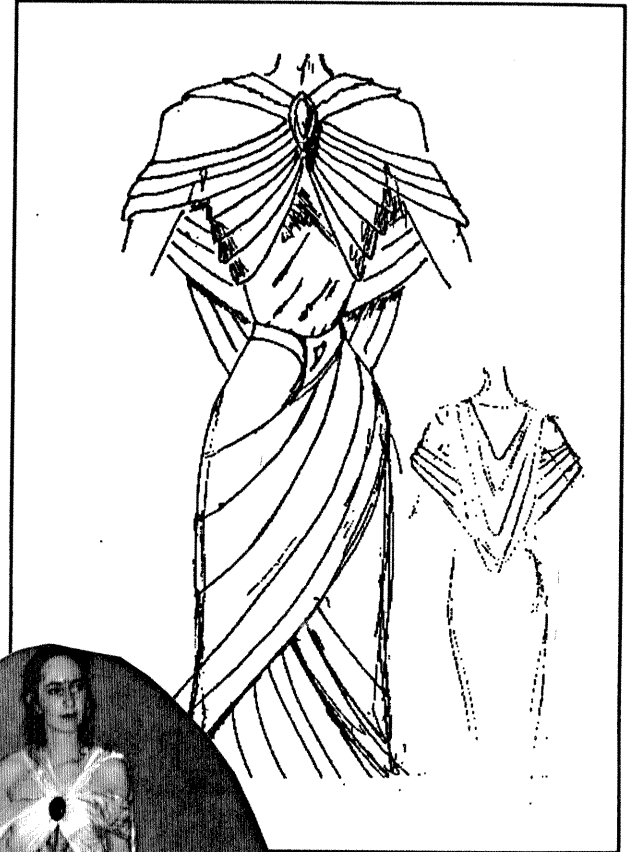

The Honeymooner's Hot Spots

Submitted by Lt (j.g.) Melissa Ulrich

There are many hot spots for honeymooners to go such as Risa and Betazed, but if you're looking for something different, here are a few of the not-so-well-known planets as according to the "Let's Trek: The Budget Guide To The Federation".

Antos IV: This is a temperate world, unpolluted, lush with plant growth, and has long, flat, white beaches and rolling turquoise seas. There are deserts and tundra, beautiful mountain ranges, and natural, mostly harmless wildlife in abundance. Hotels include the fabulous Luxor Mountain, the tallest structure on the planet. Guests can step from their room directly into a private cubicle that whisks them to the attraction of their choice at the touch of a finger pad.

Argelius II: The world where adult entertainment reigns supreme. The Argelian Humanoid Erotic Dance Troupe is praised throughout the galaxy. Their shows appeal to all genders of any sexual orientation and are not to be missed. Resorts offer large, spacious rooms with the utmost privacy. Each room has it's own private pool and Jacuzzi. Robot bartenders and chefs will see to your every culinary need. You will have access to elaborate exercise rooms and virtual reality fantasy rooms.

Scor IX: A small planet often called "Forest World" because of the hundreds of thousands of square miles of virgin woods. There are no city lights to interfere with 77 active observatories built across the planet. A vast hotel complex nestled in the forest kingdom is like a village in the sky. It surrounds trees high above the ground without cutting into them or interfering with their natural growth. Rooms bisected by a leafy branch cost extra.

Norpin V: This world is a popular tourist attraction on the top ten highly recommended list of the Federation Tourist Bureau. This world has the galaxy's largest golf courses amid lush terrain. It has quiet, temperate beaches, huge natural hot springs, a variety of modern entertainment, and luxurious affordable housing. Tourism is encouraged. There are waterparks, theaters, resorts, and hotels in every town. None are ever full. You can drop by this world on a whim without reservation.

Tarsus IV: This beautifully groomed world is known for it's vast stretches of animal preserves. Species native to this world, as well as others, are kept in environments approximating the animal's natural habitats. Hotels including the Discovery and the Hilton Habitat are located in the two coastal cities of Vormel and Natu. Each hotel has a full library on all animals living on the continent and tours are available.

Tyrus VII-A: This large, blue-green world has three huge continents embracing two gigantic inland seas. The most lovely cities in this quadrant of the galaxy can be found here. One continent, Tureng, is a year-round winter resort. Burduo is an archaeologists best dream with ancient cities still being discovered. Rendron has a year-round summer resort of beaches and lakes. All three have beautiful resorts and many fine restaurants.

So now that you have seen a few of the better and definitely most unusual planets to take your newlywed to for your honeymoon, the only thing left to do is choose the spot and enjoy!! And for all you music lovers who don't know exactly what music you should take along to help you out on this wonderful occasion, might I suggest "Cosmic Cowboy: T.D. Boone's Greatest Hits, vol 1."

Space Time Hypersurfing

In some future history, 1994 may be remembered as the year that the warp drive was first conceived to be a physical possibility. Long a cliché of science-fiction writing, the warp drive has transported countless fictional characters through lightyears of interstellar space in the time it takes for you or me to travel to the market. Unfortunately for real-world space travelers, the warp drive has always been thought to be inconsistent with the laws of physics. But all this has changed.

In the May issue of *Classical and Quantum Gravity*, Miguel Alcubierre, a physicist at the University of Wales in Cardiff describes a space-travel scenario that bears an uncanny resemblance to the warp drive of science fiction. With Alcubierre's warp drive, we could reach any place in the universe in as short a time as we please!

The warp drive envisioned by Alcubierre is made possible by the subtleties of Einstein's general theory of relativity. According to Einstein, spacetime (the union of the three dimensions of space with the dimension of time) is not an inert substrate, but rather a dynamical entity that twists and distorts under the influence of concentrations of energy. Alcubierre suggests that it might be possible to exploit this phenomenon to travel from one star to another faster than the speed of light. This could be done by creating a disturbance in spacetime such that the region directly in front of a spaceship is contracted while the region directly behind the spaceship is expanded. This distortion of spacetime would, in effect, propel the spaceship forward like a surfer riding the crest of a breaking wave.

At first glance this mechanism would appear to violate Einstein's special theory of relativity, which holds that no object can travel faster than light. Violations of this law lead to causal paradoxes, in which actors in the present can alter their own past. Yet Alcubierre shows that his warp drive does not, in fact, lead to such violations. The reason is that light also travels in spacetime, and is carried along just as the spaceship is. The light beam is still traveling at the speed of light, relative to the spaceship, which itself is not accelerating relative to the spacetime in its immediate vicinity.

Although Alcubierre's warp drive does not engender any causal paradoxes, one might still be concerned for a space traveler's welfare. To get to a distant star and back in only moments, the traveler would have to be accelerated at a very large rate, effectively turning him into soup. Or at least this would be true, if not for the fact that accelerations are relative in general relativity. Although the acceleration of the spaceship as seen by someone on Earth would be enormous, the acceleration experienced by the space traveler would be zero! The space traveler would be weightless, just as astronauts are in orbit around the Earth.

Finally, Alcubierre also shows that a traveler using his warp drive would experience no time dilation. One of the predictions of Einstein's special theory of relativity is that time flows at different rates for observers moving relative to one another. Consider two space travelers, John W. and Campbell Jr., who decide to visit the great galaxy in Andromeda, which is about 2 million light-years away. John travels in a spaceship equipped with Alcubierre's warp drive, whereas Campbell takes the old-fashioned spaceship that advertises "one Earth gravity all the way." Campbell spends most of the trip traveling near the speed of light. Because of time dilation, Campbell is able to survive the trip, aging only 60 years in the process. However, because the galaxy is 2 million light years away, about 4 million years pass on Earth before Campbell gets home. In contrast, John is able to make the journey to the galaxy and be back in time for supper on Earth!

Of course, there is no such thing as a free lunch (or supper). The key to Alcubierre's warp drive is something called exotic matter. Exotic matter has the curious property of having a negative energy density, unlike normal matter (the stuff that makes up people, planets and stars), which has a positive energy density. Two bits of matter that have the same energy density are attracted to each other by gravity. In contrast, bits of positive and negative energy matter would be repelled by gravity. It is the negative energy density of exotic matter that powers the warp drive.

A negative energy density is not the nonsensical thing it appears to be. Indeed, in 1948 the Dutch physicist Hendrik Casimir first predicted that one could observe the effects of negative energy densities. He reasoned that if negative energy densities existed, two closely spaced parallel conducting plates in a vacuum would be attracted to one another in a specific way. This phenomenon, now called the Casimir effect, was measured in 1958 by M. Sparnaay, and is usually taken to be a confirmation that negative energy densities are possible.

Exotic matter of a slightly different type is also invoked in the modern theory of cosmology known as inflation. According to the theory of inflation, exotic matter in the early universe (moments after the Big Bang) had a positive energy density, but a very large negative pressure. The negative pressure was so large that it counteracted the effects of the positive energy density. The result was an expansion of spacetime so rapid that two observers originally very close to each other would be carried apart faster than the speed of light. This paradigm of spacetime expansion provided the motivation for Alcubierre's warp drive.

There are, of course, "technical details" to be worked out before the aerospace firms can start building starships. Foremost among these is the production of exotic matter. Alcubierre has not given that aspect of the problem much thought. Although he is an avid reader of science fiction, he does not intend to pursue the subject much further. Currently, he spends most of his time working on other problems in general relativity. The warp-drive scenario, he says, is a very simple thing that he came up with in his spare time. Perhaps the problem will be taken up by some future physicists in their "spare time." The rewards could be astronomical. -Michael Szpir

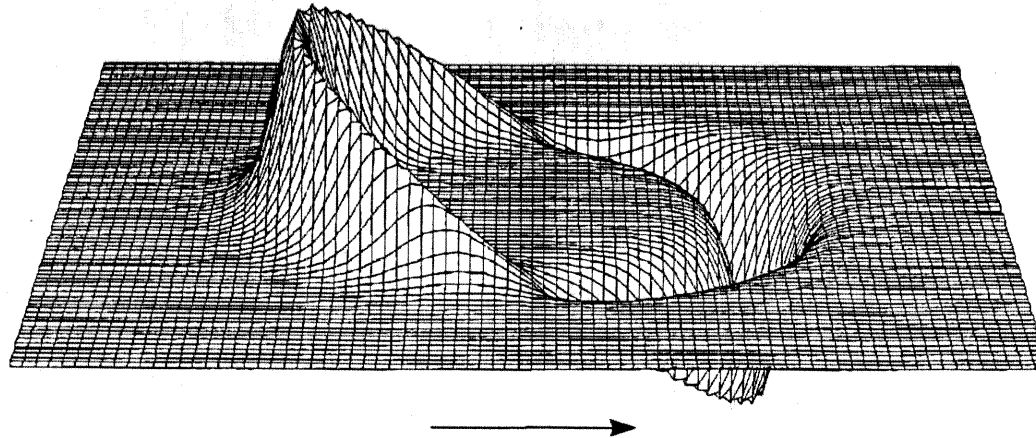

Distortion of space around a spaceship moving with Miguel Alcubierre's warp drive in the direction of the arrow. Space expands behind the spaceship and contracts in front of it.

Miguel Alcubierre

LEVAR BURTON (*La Forge*) **What he's doing:** Directed an episode of *Voyager* and will direct the independent film *Stairway to Heaven*, a romantic comedy. Hosts PBS' *Reading Rainbow*. Will star in upcoming episodes of CBS' *Christy*. **Is there life after *Trek*?** "See, I had a life *before Trek*."



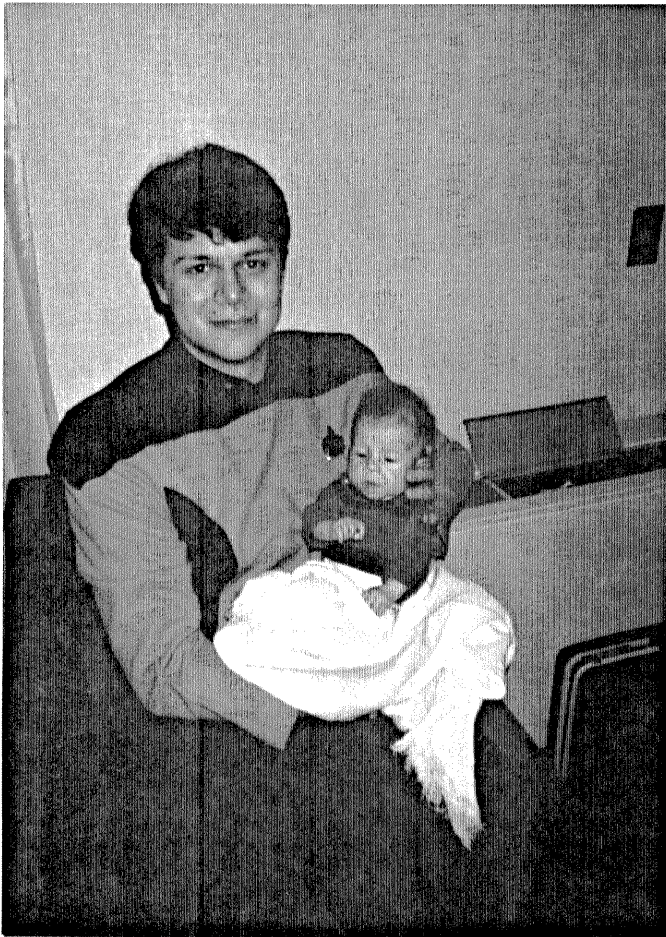

KES RUSSELL

Born: 02-27-95 1:22 am
6lbs 13 1/4 oz.
20 inches long

"The Newest
member
of the
KELLY"

Parents: Rob and Teresa Russell

← Rob and Kes, a new member to his security team!

Paramount Parks To 'Beam Aboard' Las Vegas Hilton

BY SHANNON McMULLEN

LAS VEGAS— Hilton Hotels Corp. and Paramount Parks, a division of Viacom, have joined in a collaborative effort to build an \$50-million entertainment complex at the Hilton here entitled "Star Trek: The Experience".

The venture will permanently occupy 50,000 square feet in the north tower of the 3,174-room property and is scheduled to open in December 1996, coinciding with the 30th anniversary of Star Trek.

According to Gary Gregg, president of the Las Vegas Hilton, Star Trek was chosen because it appeals to the hotel's major market— adults, while it also can be enjoyed by

the whole family. "Thus, we are appealing to our main demographics while remaining a family-friendly property," he said. Gregg added that the attraction is expected to "enor-

Incorporating interactive video and virtual reality stations, the attraction will allow visitors to assume the identity of a Starfleet or alien crew member and participate in the world of Star Trek.

Several other area hotels have opened with themes in the past few years; the Luxor with an Egyptian theme and the MGM Grand with an adjoining motion picture theme park, as these attractions become more popular to obtain family market share.

Star Trek: The Experience marks

Paramount's first development of such an attraction outside its theme park operations and in the gaming area.

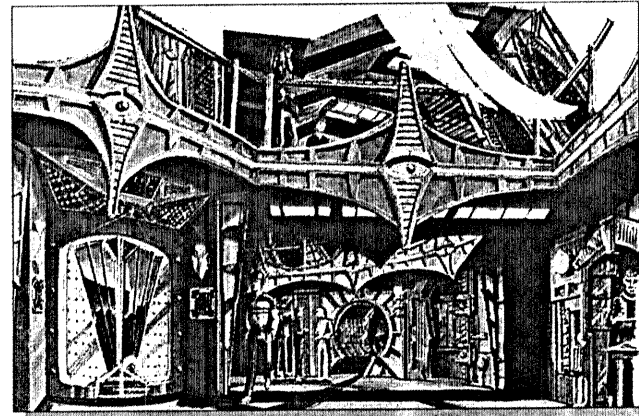

Star Trek: The Experience will launch visitors into a technologically advanced interactive entertainment experience with the help of simulated rides and virtual reality stations.



GATES MCFADDEN (*Beverly Crusher*) **What she's doing:** Costarring in UPN's *Marker*, shooting on location in Hawaii. **Do you keep in touch with**

the other cast members? "Only the ones who sit around their house in their [*Trek*] uniform."



WIL WHEATON (*Wesley Crusher*) **What he's doing:** Recently finished filming *Mr. Stitch*, a feature to be released this summer. Worked at NewTek,

a computer company, in the computer-animation division. **Is there life after *Trek*?** "You mean, will I be on *Battle of the Network Stars*? No. I don't want to be that 16-year-old guy that everyone recognizes."

STAR TREK: VOYAGER

When Al Hirschfeld's daughter was born in the early '40s he started putting her name in his drawings. After a while it became a contest to find how many times he did put her name in. Collectors of his work have always tried to find her name. Can you? It's Nina.



QUOTE OF THE MONTH

"I'M A DOCTOR, NOT A NIGHT LIGHT!"

MISQUOTE OF THE MONTH

"DID YOU SAY 'WHAT WOULD YOU THINK OF A 4TH RATE SHRIMP GRINDER?'"

ya'll come back
now...
ya hear! "

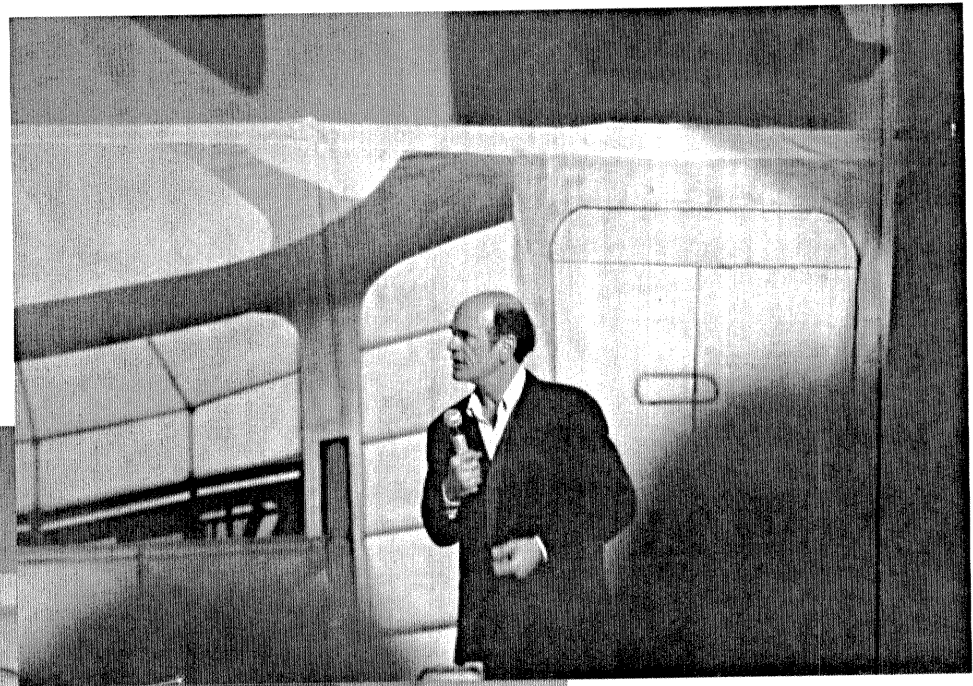

Editing Staff
ENGINEERING DEPARTMENT

THE KELLY COMMUNIQUE IS A NON-PROFIT NEWSLETTER
PUBLISHED AS A MEANS OF COMMUNICATION BETWEEN STAR TREK FANDOM
IT DOES NOT INTEND TO INFRINGE UPON ANY RIGHTS.
"STAR TREK" IS A REGISTERED TRADEMARK
OF PARAMOUNT PICTURED CORP.
ALL RIGHTS ARE RESERVED TO ORIGINAL WORK HEREIN.
NO COPYING WITHOUT THE PERMISSION OF THE INDIVIDUAL AUTHOR.

Starcon 95

THE SCIENCE FICTION CONVENTION

In Person

Kate Mulgrew

Captain Katherine Janeway

Star Trek Voyager

September 22-24, 1995

Holiday Inn DIA • I-70 & Chambers Rd

for more information, call 671-TREK (8735)

Don't miss the excitement! Memberships are available here at Starfest for only
\$25.00 for the entire weekend of fun.