

**KELLY**

**COMMUNIQUE**

**VOLUME THIRTY NINE**

**MARCH / APRIL 1996**

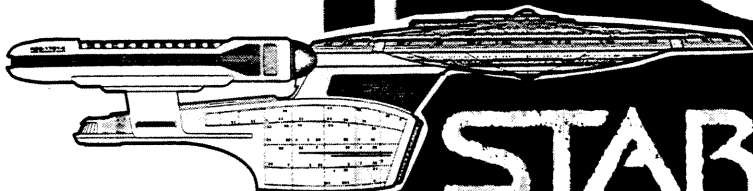
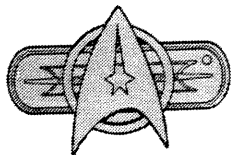
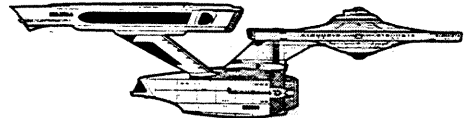
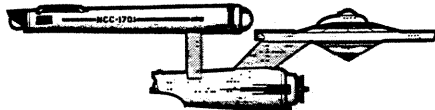
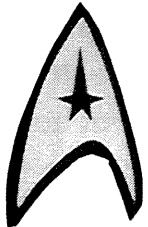

**STAR TREK**  
**3 0 Y E A R S**

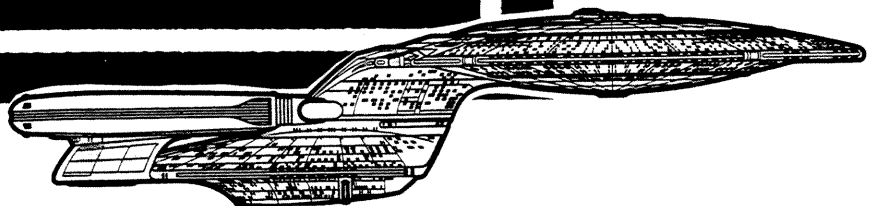

# LOG ENTRY

Chief Records Officers Log, Stardate: 49030.1

You may wonder why this communiqué is so different from some of the past ones. Mainly it is because this is my novice attempt on the COMPUTER. I have been trying to work out a Mac PowerBook 160. So please bare with me in my first attempt at doing the newsletter on a computer.

**THIRTY YEARS OF STAR TREK!** Believe it or not, this phenomenon has been going for more than that. What I wanted to do was show you the way it began and how it has grown and changed during this time. One way to do that, I figure, is to show you pictures of the stars, then and now, as well as some of the changes that have been made over the years in some of the characters. In our stargazer segment I have photos that were taken at the 30th. Con in Pasadena last Nov. Suzanne Reading was kind enough to give me the photo of the "Big Three" that I think is a truly wonderful picture. She also has some she had taken with some of the original crew at that convention in Nov. '95.

How many of you saw the Screen Actors Guild Awards? I taped the part about Star Trek's 30 years showing each of the crews from TOS to Voyager. Most of the stars from the shows were at the awards and it was great to see them all there on the same stage together. Rick Berman and Majel Barrett Roddenberry accepted the awards. It was really special.



***HIS DREAM  
GOES ON  
AND ON  
AND ON!***

Dedicated to  
GENE RODDENBERRY  
with love.

# ASK NUMBER ONE

The question has been asked about what Star Trek was like in the beginning, and how it has changed. Gene Roddenberry's original concept of Star Trek is somewhat different than what finally ended up on television. Below are some sketches of early designs for the U.S.S. Enterprise, which was not going to be called Enterprise at all, but would have been named the S.S. Yorktown. This ship would have carried only 203 crew members as opposed to the 430 that served on the Enterprise. Her top speed was approximately three quarters of a light year per hour. She was known as a Starship class vessel, which was later changed to a heavy cruiser type. It was designated as a United Earth ship, because the United Federation of Planets was not introduced until later in the series. The crew was also much different than the one we grew to know and love. The captain was named Robert M. April. There were several actors who auditioned for the role of Captain April, among which were Jack Lord of Hawaii Five-O fame, and Lloyd Bridges of Sea Hunt. The captain's name was changed to Christopher Pike and actor Jeffrey Hunter was cast in the part. Mr. Hunter was unable to return for the second pilot filming so the captain's name was changed again, this time to James Kirk with veteran actor William Shatner in the role. In the episode "Where No Man has gone Before" the middle initial "R" was carved in Kirk's tombstone. It became "T" later on, but was not revealed to stand for Tiberius until the animated episode Bem. The First Officer was a woman, known only as Number One, highly intelligent, non-emotional and extremely efficient. The navigator was a man by the name of José Ortega. The ship's resident physician was Dr. Phillip "Bones" Boyce. They kept the nick-name but sought a second opinion and got a new doctor. The first lieutenant was an odd looking fellow with a red complexion, satanic features and pointed ears. He was said to be half martian, and didn't have a logical bone in his body. His name was Spock. The name stayed the same, but the character was changed to protect the innocent. Other cast changes and character definition continued as time went on. The original pilot episode was never seen as a T.V. episode, although it was cut up and portions of it were used to make the two-part episode "Menagerie". The characters in this first pilot were much closer to Gene's original ideas, but many changes were made in order to make it saleable as a T.V. series. Many of the original episodes were changed as well. Some had major rewrites while others didn't make it to the screen at all. A lot of the titles were changed also. See if any of these sound familiar to you:

The Perfect World. Mr. Socrates. The Stranger. Reason II. A Matter of Choice. The Radiant One. The Trader. A Question of Cannibalism. The Mirror. Torx. The Pet Shop. Kongo. The Venus Planet. Infection. There were many other changes, which continued the whole time that the series was airing. No one, not even Gene Roddenberry, could guess how Star Trek would change over the years. It is still Star Trek. It is still the dream created by Gene, but it really has "gone where no man has gone before." And it will continue to change and grow, as long as fans give it life.

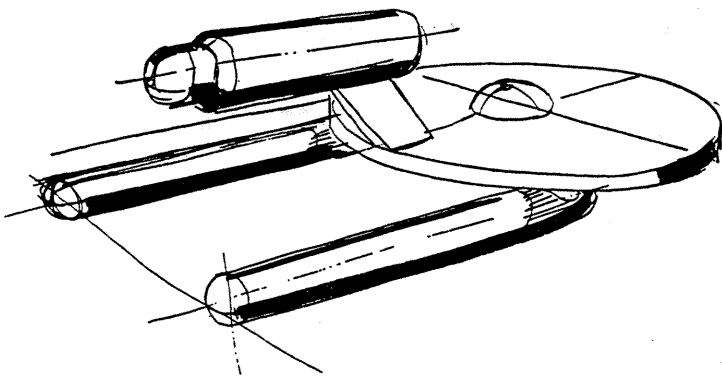

EARLY SKETCHES OF ENTERPRISE

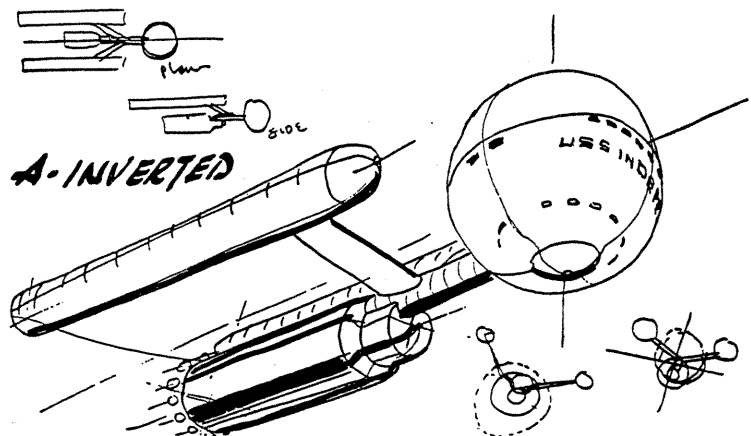

If you have anything you'd like to know or question answered, submit it to me, and I'll try to answer it for you. Just ASK NUMBER ONE!

# CETUS CLASS STARSHIP

5457	82	487	23	8	52371	2	58	457	302	7840	54	58	4779	88	2	3481834731423885184	52	28
					234	457	8	555	22	773	31	4388	41	48	881840848383		43	
					547554	5	72	9	47	88	7	22	832	8	87	88	157	593
					8	48	80	47	51	444	8	9	88	2	8		457	478
					5887211	8	47	2	2	8	824	1	238	710	4	74	125	111
					83	7	3878	40	439	27			78	1	3	27	5	3
					5584	9	45	78	3	888	1	88	49	3	3	4885848481821584581818	28	12

CET

DE HOL

PORT ELEVATION

LCARS

DORSAL PLAN VIEW

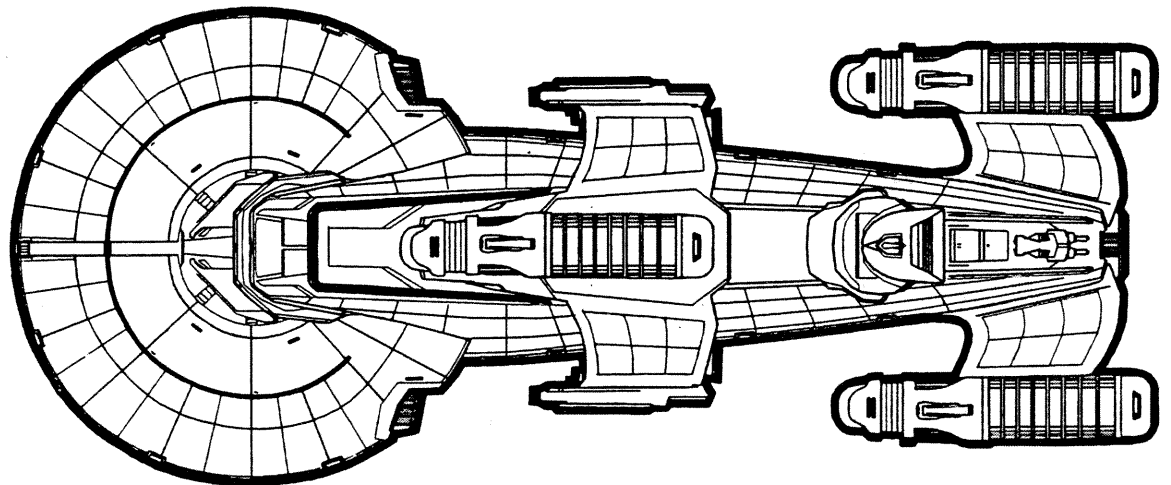
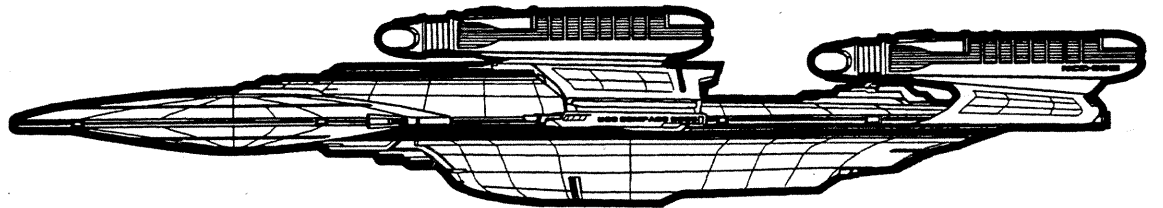

UNITED FEDERATION OF PLANETS • STARFLEET COMMAND  
U.S.S. COMPASS ROSE NX-8816

## MOBILE SERVICING FACILITY

# Happy Birthday

## March

- 2- Glen Bogue
- 3- Jimmy Doohan
- 4- Justin Roviére
- 10- Bob Torres
- 15- Charlene Harmon
- 20- John de Lancie
- 21- Ted Wentz
- 22- William Shatner
- 26- Leonard Nimoy
- 29- Marina Sirtis

## April

- 1- Grace Lee Whitney
- 4- Rex Roviére
- 7- Steve Ford
- 8- Pat Conroy
- 10- Jill Hiatt
- 14- Tina Weidauer
- 18- Avery Brooks
- 19- Vicki Roviére
- 20- George Takei
- 25- Ruth Barks
- 29- Kate Mulgrew



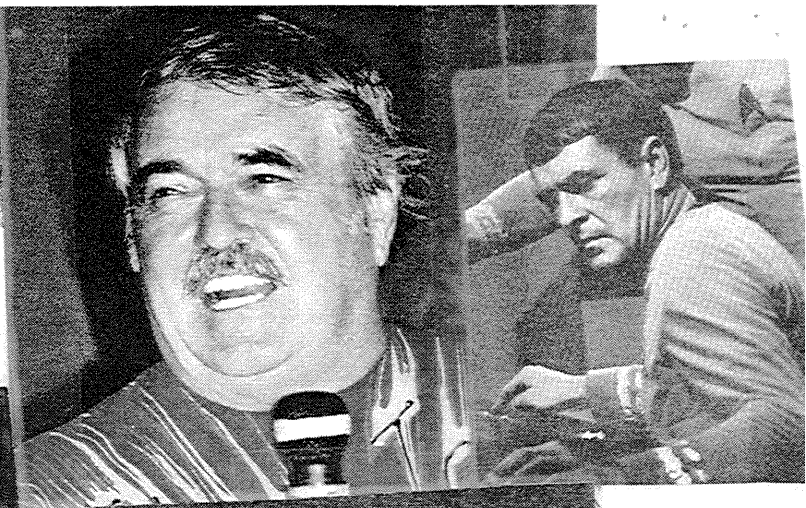
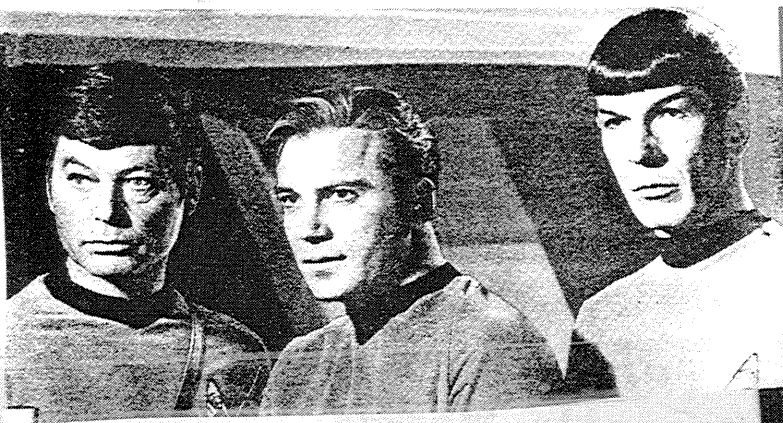



# KLINGON METAMORPHOSIS



*Kang and Kor*

*From The Original Series:*

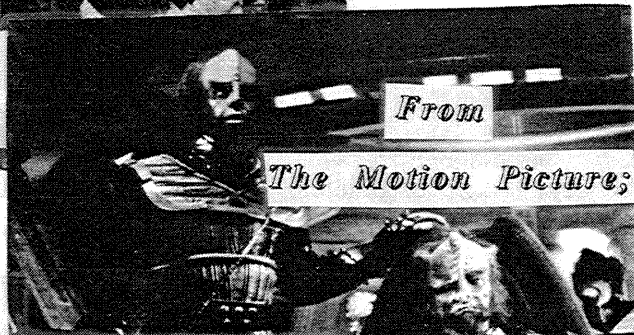

*From  
The Motion Picture;*



*Above: Colicos as updated Kor.  
Left: Colicos today.*

*Above: Ansara from DS9's "Blood  
Oath." Right: Ansara today.*

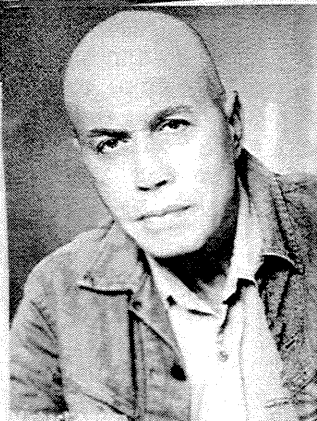
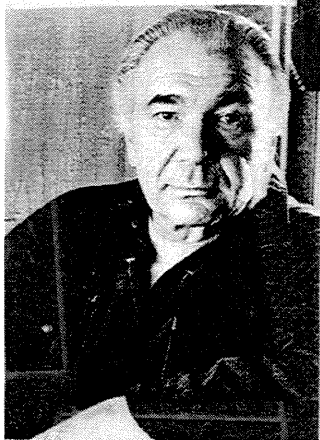

*and*



*Worf's changes*



*during*



*the seven*



*years of*



*The  
Next-Generation*

If Dr. Seuss wrote for Star Trek: The Next Generation...

Picard: Sigma Indri, that's the star,  
So, Data, please, how far? How far?  
Data: Our ship can get there very fast  
But still the trip will last and last  
We'll have two days til we arrive  
But can the Indrans there survive?  
Picard: LaForge, please give us warp factor nine.  
LaForge: But, sir, the engines are offline!  
Picard: Offline! But why? I want to go!  
Please make it so, please make it so!  
Riker: But sir, if Geordi says we can't,  
We can't, we mustn't, and we shan't,  
The danger here is far too great!  
Picard: But surely we must not be late!  
Troi: I'm sensing anger and great ire.  
Computer: Alert! Alert! The ship's on fire!  
Picard: The ship's on fire? How could this be?  
Who lit the fire?  
Riker: Not me.  
Worf: Not me.  
Picard: Computer, how long til we die?  
Computer: Eight minutes left to say goodbye.  
Data: May I suggest a course to take?  
We could, I think, quite safely make  
Extinguishers from tractor beams  
And stop the fire, or so it seems...  
Geordi: Hurray! Hurray! You've saved the day!  
Again I say, Hurray! Hurray!  
Picard: Mr. Data, thank you much.  
You've saved our lives, our ship, and such.  
Troi: We still must save the Indran planet --  
Data: Which (by the way) is made of granite...  
Picard: Enough, you android. Please desist.  
We understand -- we get your gist.  
But can we get our ship to go?  
Please, make it so, PLEASE make it so.  
Geordi: There's sabotage among the wires  
And that's what started all the fires.  
Riker: We have a saboteur? Oh, no!  
We need to go! We need to go!  
Troi: We must seek out the traitor spy  
And lock him up and ask him why?  
Worf: Ask him why? How sentimental.  
I say give him problems dental.  
Troi: Are any Romulan ships around?  
Have scanners said that they've been found?  
Or is it Borg or some new threat  
We haven't even heard of yet?  
I sense no malice in this crew.  
Now what are we supposed to do?  
Crusher: Captain, please, the Indrans need us.  
They cry out, "Help us, clothe us, feed us!"  
I can't just sit and let them die!  
A doctor MUST attempt -- MUST try!  
Picard: Doctor, please, we'll get there soon.  
Crusher: They may be dead by Tuesday noon.

\*COMMERCIAL BREAK, COMMERCIAL BREAK  
HOW LONG WILL THESE DUMB ADS TAKE?\*

Worf: The saboteur is in the brig.  
He's very strong and very big.  
I had my phaser set on stun --  
A zzzip! A zzzap! Another one!  
He would not budge, he would not fall,  
He would not stun, no, not at all!  
He changed into a stranger form  
All soft and purple, round and warm.  
Picard: Did you see this, Mr. Worf?  
Did you see this creature morph?  
Worf: I did and then I beat him fairly.  
Hit him on the jaw -- quite squarely.  
Riker: My commendations, Klingon friend!  
Our troubles now are at an end!  
Crusher: Now let's get our ship to fly  
And orbit yonder Indran sky!  
Picard: LaForge, please tell me we can go...?  
Geordi: Yes, sir, we can.  
Picard: Then make it so!

THE END

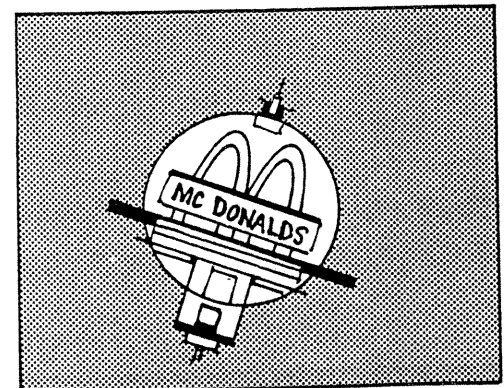
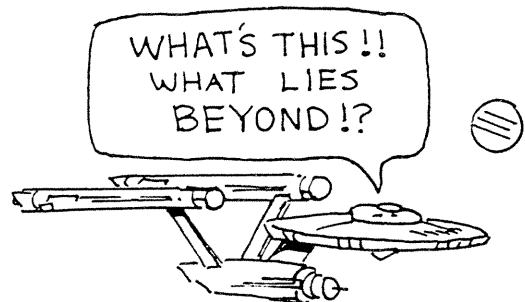
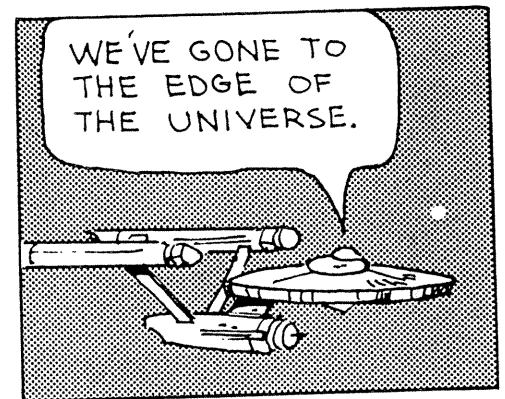



# ***SEVEN THINGS YOU NEVER SAW ON STAR TREK***

1. The shields on the Enterprise stay up during a battle.
2. The Enterprise runs into a powerful energy field of a type it has encountered several times before.
3. The Enterprise checks on a remote outpost of scientists, who are all just fine.
4. A power surge on the bridge fails to electrocute a computer operator, thanks to a highly sophisticated 24th century surge protection device called a fuse.
5. The Enterprise crew discovers a totally new lifeform, which later turns out to be a rather common old lifeform wearing a silly hat.
6. Kirk gets into a fistfight without ripping his shirt.
7. The Enterprise is captured by a vastly inferior alien intelligence which the crew easily pacifies by offering it some sweets.

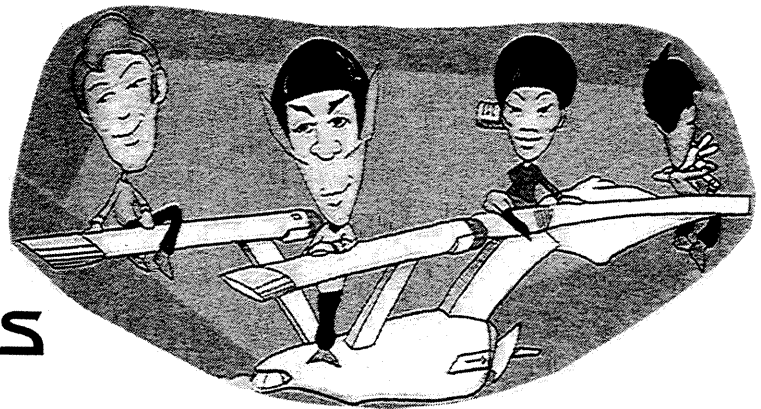

## **Announcements**

### **March Activities**

**March 9 at Hill AFB Air Museum at 1 p.m. with the U.S.S. Turner Joy.**

**March 16 Cinemaholics/Carol Mahoney mini-convention at the Quality Inn–City Center. Meet Jennifer Hettrick (Vash) and others. The cost is \$15.00. From 10 a.m. to 5 p.m.**

### **April Activities**

**April 12 Model Night (location to be determined) Bring a favorite model to put together or come and watch others.**

**April 19-21 Starfest in Denver with Kate Mulgrew (Captain Janeway) Also Grand Slam in Pasadena, California in case anyone is interested and can afford it.**

# ***BATTLING BATTENS DISEASE***

Clair McLean lost two daughters to Battens Disease and is now working to gain a cure for this rare disease before the beginning of the 21st Century. What she has been doing has been running marathons to gain support from various companies in this area. This March 3rd she will run the L.A. Marathon. She has written to the crew of Voyager and the following is her idea of what each of the crew's response to her letter would be.

Captain Janeway: "I can only imagine how much this marathon means to you and how much you must grieve over the loss of your daughters. In some ways, I can relate what it feels like to be so close to them and yet so far away. All of us on VOYAGER miss our families and loved ones, and I'm not sure how much you can relate to that. (She looks out at the distant stars.) As hard as your situation may seem for you right now, I don't think your circumstances are more difficult than ours. Unlike you, we don't know what's been happening to our people back home or if they've given us up for dead, and we can't be there for them.....maybe somehow, for those who are more in tuned, they know we're alive.....(turns back around facing me). Well, you've worked hard for this. Knowing your determination, I'm confident that you'll succeed!"

Commander Chakotay: (Scene on the Holodeck, a mountainous desert on a clear, summer night, and above are the sidereal heavens with the background noises of crickets and other nocturnal desert life-forms. We're sitting across from each other at a small campfire. He possess a genuine nobility of spirit about him which emanates from deep within his soul, he is attired in his Native American garb.) After beginning a prayer to the spirits "among these unnamed stars," he studies my eyes and face for a minute or so. The flickering light from the campfire creates an ambiance that holds my attention to every word he says. The warm glow of the fire adds to the strength of character in his face. "You will feel the spirits of your ancestors and your daughters as you run, and if you allow them to, they will help you rise above your challenges in the same way the eagle spreads forth his wings to let the warm air currents watch over you because you, too, have a difficult path to travel..... Akoohemoya."

Lieutenant Tuvok: (Scene, sitting at a table in the recreation area--the two of us.) "It is important that you take some time during your training to meditate at least a half-hour of your time each day. Speaking from my own experiences in my training on Vulcan before I entered the Academy, I found that deep meditation before our rigorous physical training, which included long runs, helped me to stay focused on my goals. With your strength, you will increase your endurance level."

Lieutenant Tom Paris: (same scene as above) "I've done a bit of running, too, but it wasn't at any sporting competitions! But I do admire your courage and commitment. You know,

you remind me of one of my cousins who lost her husband and two boys during the Borg attack at Wolf 359. It took her a few years to pull her life back together and the last I heard from her, she'd submitted her application to return to the Academy to become a counselor. (looking a bit more serious) We were pretty close, and she was always there when I was growing up if I needed someone to talk to, and I miss that right now...(shakes his head a little) I'm sorry. I know you'll do well. I can see it in your eyes...and that reminds me that I've got an appointment with a pretty young ensign at the flight simulator. She wants to sharpen her piloting skills," he says with a twinkle in his eyes. "Good luck on your run!"

The Doctor (Who?): "Please state the nature of your problem. (pause) Oh, It's advice you want. Just use common sense! You've run two marathons before, so you know the basic rules. Pay attention to your heart rate, drink lots of water a few days before and during this insane activity. I needn't remind you of carbo-loading before the run, since I know most runners love eating pasta, and you're probably no exception! Keep your spirits high. Enjoy your run---although I personally think that's a contradiction in and of itself!"

Chief Engineer B'Elanna Torres: (scene, Engineering) "You have a lot more strength than you think you do! Before I dropped out of the Academy, I ran some marathons, and I came in under 3 hours every time. But I haven't run competitively since then. I prefer a good workout for a few hours on the holodeck occasionally with a Bat'telh. I suspect you carry a lot of anger around, too. I recognize it in your face. (looking somewhat distant) ....All too often, we underestimate our abilities and past achievements. I certainly did....(looking a little more spirited). You have the drive and determination to do more than you ever imagined. If nothing else, that's what we've learned about ourselves out here. So if you ever feel alone, remember---so have we, and we've risen above that despite our differences, and so can you! Maybe I'll reprogram the Holodeck and run another marathon myself!"

Ensign Harry Kim: (scene, Holodeck, old San Francisco, on the shore below The Golden Gate Bridge) "I've run in the San Francisco Marathon twice, but most of my running would be on week-ends. I've found that I had more energy when I'd think about other things besides the run, such as my friends, special events, different situations I'd be dealing with or just looking at the surroundings, like the quaint houses and other buildings, or maybe some unusual trees. I would discipline myself to pay attention to other things rather than how tired I was getting; it helped me to keep going, and it'll work for you, too. Good luck!"

Kes: (scene, Arboretum, and she's working with her plants and talking while I'm watching) "I sense that you're feeling a great deal of emotional pain over the loss of your daughters . . . and the many losses you incurred growing up. (stopping for a moment after receiving more vibes) And you're trying to fill up the empty space in your life with your obsession to fight the disease that killed your girls---the empty space they once occupied in

your heart. Please, don't misunderstand my comments. What you're doing is admirable, but remember to take care of yourself and find some time just to enjoy the beauty of the outdoors and quiet moments to replenish your soul. That's why I like working with our plants where it's quiet and peaceful. (putting her hand on my shoulder while facing me) And remember that Erica & Emily are in a beautiful dimension of life that we cannot see, and I sense that they'll always love you. Go in peace."

Neelix: (scene, in the kitchen) "Pasta-Schmasta! I can prepare you a meal the night before your marathon that will give you enough energy and vitality to run the entire distance in less than two-and-a-half of your hours! It's made from some plants indigenous to the Kazon home-world, and because it's a staple in their diet, it has given them a greater strength and endurance level than humans have. Like your soybeans, these nutritious seeds (holding about a tablespoon of them in his hand) can be processed to resemble your favorite food so closely that you'd never be able to tell the difference (pours them back into a canister)--as long as you have a connoisseur who knows what he's doing--and I'm the one who can do it! (stops a minute and thinks) "Maybe it's time I told the rest of the crew about it. Kes and I use it, and that's why we function so well with one lung apiece! Think what it can do for you, with two lungs!"

Well, I hope you all enjoyed that, but it won't be near the delight that I have watching your show. If I sound a bit starry-eyed, it's because I am! I love Star Trek, especially VOYAGER.

Live Long and Prosper . . .  
And May the Force Be With You . . .  
ALWAYS!

Claire Mc Lean

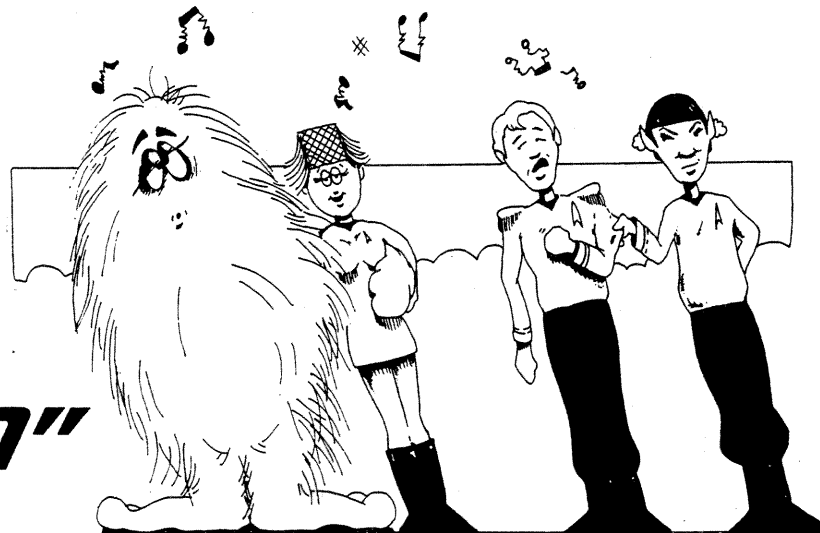

## ***"TENURE RIBBON"***

We have a ribbon that will signify the length of active membership aboard the U.S.S. Kelly. In order to receive this you must apply one month before your next anniversary date. The Kelly will buy your first ribbon and number,



## **DID YOU KNOW?**

Here is something to consider about Star Trek:

It is seen in more than 100 countries and has been translated into more than 40 languages.

A convention is held somewhere in the world every weekend, collectively attracting about A Million Fans !!

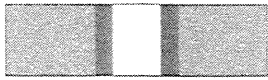

**MEDAL OF HONOR**  
HIGHEST AWARD OF THE UNITED FEDERATION OF PLANETS



1ST CLASS

**CLASS OF EXCELLENCE**  
GIVEN FOR PERFORMANCE ON ACADEMY TEST  
80-100% 1ST CLASS, 50-79% 2ND CLASS



**AWARD OF VALOR**  
HIGHEST AWARD OF STARFLEET COMMAND

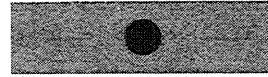

2ND CLASS

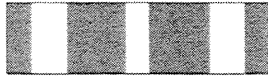

**GRANKITE ORDER OF TACTICS**  
GIVEN FOR EXCELLENCE IN STARSHIP SIMULATION COMBAT



1ST CLASS

**PRANTARES RIBBON OF COMMENDATION**  
GIVEN FOR ATTENDANCE AT STAR TREK CONVENTIONS  
(25) 1ST CLASS, (15) 2ND CLASS

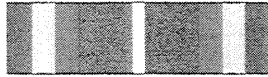

**STARFLEET CITATION FOR CONSPICUOUS GALLANTRY**  
GIVEN FOR OUT-STANDING LEADERSHIP



2ND CLASS



**KARAGITE ORDER OF HEROISM**  
WOUNDED IN THE LINE OF DUTY

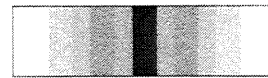

'94

**DISTINGUISHED SERVICE AWARD**  
GIVEN FOR OUT-STANDING SERVICE



**LEGION OF HONOR**  
GIVEN FOR OUT-STANDING PERFORMANCE WITHIN DEPARTMENTS



'95



**STAR CROSS**  
GIVEN TO A 10 YEAR MEMBER OF STARFLEET COMMAND  
(NEVER BEEN ON IN-ACTIVE LIST)

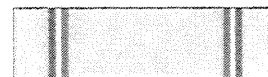

'96



**COCHRANE AWARD**  
GIVEN TO INDIVIDUALS WHO HAVE DEMONSTRATED SUPERIOR ABILITIES IN TRIVIA OR TREKNOLOGY



**MISSION COMMAND RIBBON**  
GIVEN TO A STARSHIP COMMANDER AFTER COMPLETING A TOUR OF DUTY



**DECORATED BY STARFLEET INTELLIGENCE**  
GIVEN TO THE TRIVIA TEAM



**DECORATED BY STARFLEET MILITARY**  
GIVEN TO THE PAINT BALL TEAM

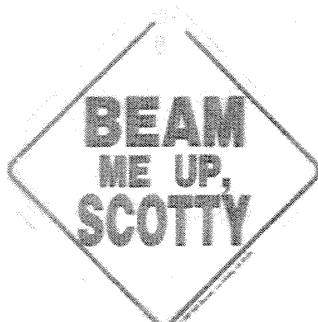
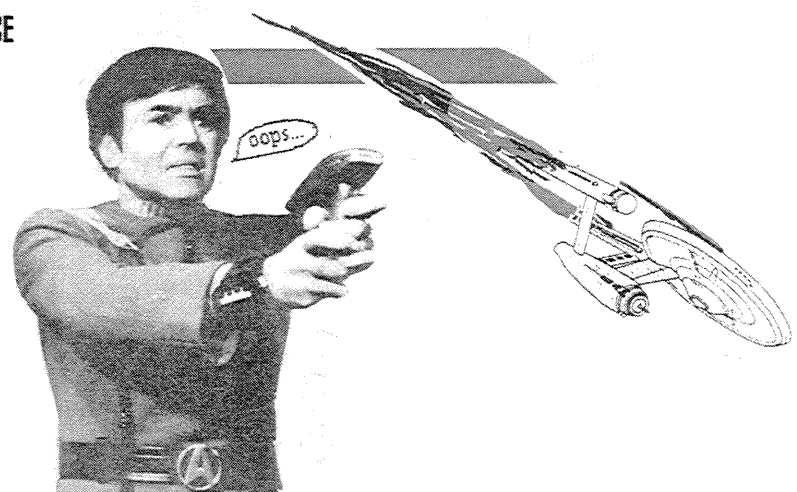

**RIBBONS • U.S.S. KELLY NCC-73400**

"Trekkies," now called "Trekkers," are the only fans listed by name in the Oxford English Dictionary.

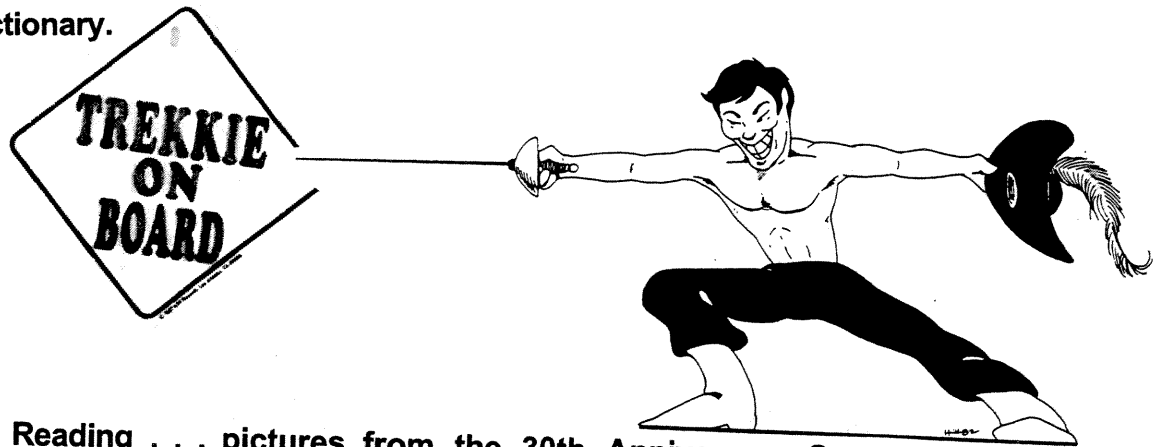

From Suzanne Reading . . . pictures from the 30th Anniversary Convention in Pasadena, CA last November.



## STAR TREK: THE TIMELINE

1964: Desilu Studios tries to sell *Star Trek* to CBS, which declines and decides to air *Lost in Space* instead.



Text by David E. Thigpen

Sept. 1966: NBC broadcasts first episode, *The Man Trap*: Kirk outwits a vampire-like alien who has eyes for McCoy.

March 1967: McCoy says, "Dammit, Jim, I'm not a bricklayer, I'm a doctor!" First variation on this phrase.



1967: Even at its ratings peak, *Star Trek* ranks No. 52, behind such shows as *Mr. Terrific* and *Iron Horse*.

Dec. 1967: *Trouble with Tribbles*, peak of *Star Trek* humor.



Summer 1968: NBC announces cancellation of series but receives 1 million letters of protest and renews it.

# KIRK'S TOP 10 REASONS FOR VIOLATING THE PRIME DIRECTIVE

According to the Prime Directive, Kirk and company may not intervene in the normal social development of any planet. Also, if the inhabitants of the planet do not know of extraterrestrial life, Starfleet officers must not reveal their origins or operate any devices that may give the locals the impression that the officers come from the stars.

10. The stupid machine that ran the planet didn't allow any touching and kissing. ("The Apple")
9. It was the beginning of a new duty cycle and I wanted to get it off to a great start.
8. The stupid computer that ran the planet didn't know how to throw a decent party. ("The Return of the Arcons")
7. Women on backward planets are really impressed when you materialize in front of them.
6. The inhabitants were using a bunch of stupid computers to fight their war....like pantywaists. ("A Taste of Armageddon")
5. The desk-hugging commodores at Starfleet Command needed something to do.
4. I always wanted to conquer a planet. ("A Piece of the Action")
3. McCoy's blood pressure had dropped to 170 / 100.
2. It makes Spock's eyebrow twitch.

And Kirk's number one reason for violating the Prime Directive.

1. I noticed my hairline receding that day.

—GOOD-BYE—

We have two members resigning their positions as of the end of February. Tactical/Conn Chief, Lt. Comdr. T.D. Boone and Security Chief Lt. Cmdr. Carl Stark who is moving to Layton because of a job change. We will miss them and wish them well.



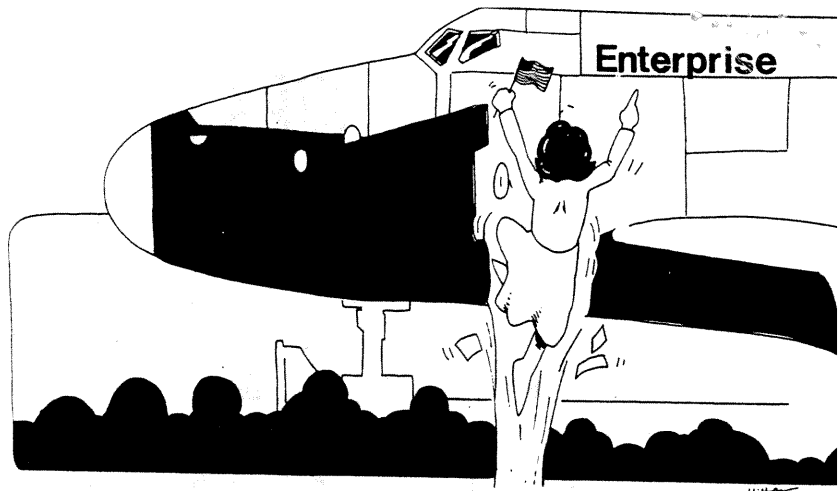
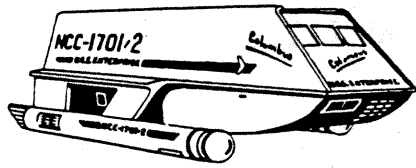

## DID YOU KNOW?

The first space shuttle was named "Enterprise" after NASA received 400,000 requests from STAR TREK fans.

A 1993 study from Purdue University found that children learn more about science from STAR TREK than anything else outside the home.

## STAR TREK: THE EXPERIENCE! IN LAS VEGAS!

On Jan. 24th top executives from Hilton Hotels as well as Paramount Parks held the official groundbreaking ceremony for this attraction in Las Vegas.

This is something we have been waiting for and it will be opening next spring ( in 1997).

If you have questions please E-Mail Evan J. Malik at: [Snoop@vegas.infi.net](mailto:Snoop@vegas.infi.net) and He'll try to answer them for you.

### DO YOU KNOW HOW TO DO SPOCK'S HAND SIGN?

We are going to use that hand sign to show respect at meetings. When you see that hand sign it means that you are to put your hand up in reply and stop talking. We will be doing this at meetings from now on.



Dec. 1982: *Star Trek II: Wrath of Khan* released; it features Kirstie Alley and Ricardo Montalban's cleavage. Spock dies.



June 1984: *Star Trek III: The Search for Spock*. Spock lives!

1986: *Star Trek IV: The Voyage Home*. In 1980s San Francisco, Spock and Kirk save the whales.



1986: In *Saturday Night Live* skit, Shatner tells convention of Vulcan-eared Trekkies to "get a life."



1987: *Star Trek: The Next Generation* TV series debuts with Shakespearean actor Patrick Stewart on the bridge and an android riding shotgun.

Oct. 1990: With 80th episode, *TNG* surpasses original series. Classic *Trek* fans aghast.





# **RAFFLE!!! RAFFLE!!! RAFFLE!!!**

We are doing a fund raiser for Clair McLean who would like to go to the Battens Conference. We will be raffling off the position of Captain of the U.S.S. Kelly for a day and you will receive a Mission Command ribbon at that time. Check it out on the Ribbons page in this Communiqué. This will also be put on your record with Starfleet Command.

Records department will be selling tickets at the next few Activities. **BUY YOUR CHANCE FOR A DOLLAR.** Just a dollar!! That's cheap so get lots! Remember it's for a good cause and you just might win "Captain for a day". You can get as many tickets as you want and can afford. You can also order them by sending the money to 4271 W. 3930 S. West Valley City, UT. 84120. Send your donation right away so you can get your chance for "CAPTAIN FOR A DAY" Remember this cause is our service project at this time.



## **DID YOU KNOW?**

**STAR TREK: VOYAGER** is the only television show in TV Guide history to be featured on the cover before editors could even see the show.

When **STAR TREK: VOYAGER** premiered in Jan. '95, there were more than 325 hours of original **STAR TREK** programming, including classic **STAR TREK**, the seven **STAR TREK** feature films, **STAR TREK: The Next Generation** and **STAR TREK: Deep Space Nine**. A person could watch **STAR TREK** programming eight hours a day, seven days a week, for nearly six weeks before he/she would run out of original material!

<p><b>1991: Gene Roddenberry dies.</b></p>  <p><b>March 1992: "Star Trek the Exhibition" opens at the National Air and Space Museum and becomes the most heavily attended exhibit ever.</b></p>	<p><b>Jan. 1993: Spin-off series Deep Space Nine debuts. Alien soap opera.</b></p> 	<p><b>Nov. 1994: Star Trek Generations. Kirk dies. Really.</b></p> 	<p><b>Jan. 1995: Star Trek: Voyager premieres. Lost in space.</b></p>  <p><b>24th century: Star Trek forgotten; cult forms around Shatner's '80s cop show, T.J. Hooker.</b></p>			
1990	1991	1992	1993	1994	1995	24th century

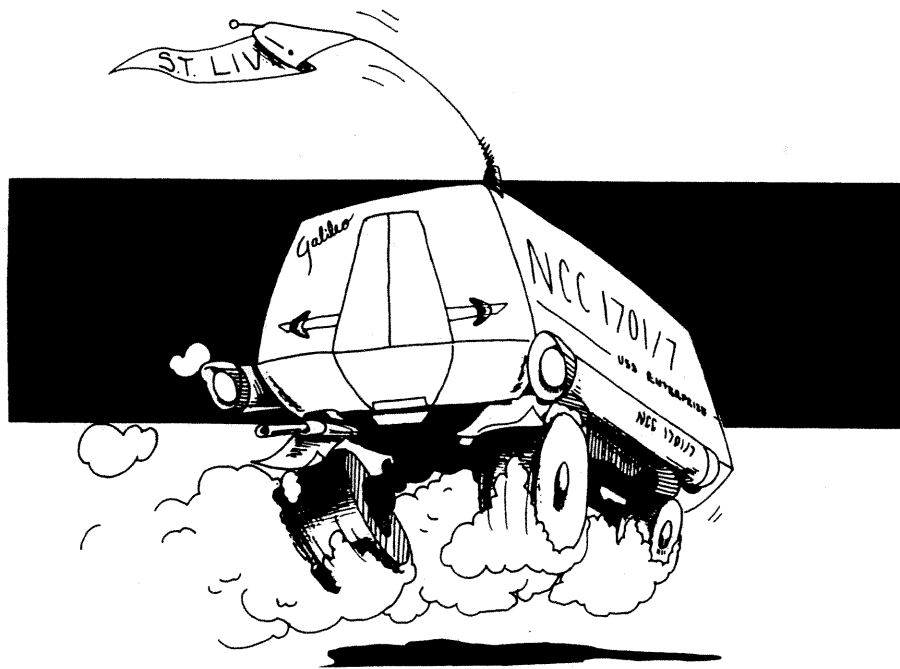

## ***Quote of the Month-***

**"Who am I to argue with the Captain of the Starship Enterprise?"**

**Kirk to Picard--Generations**

**EDITOR:**

**Lt. Ruth J. Burns**

**CONTRIBUTORS:**

**Captain Dennis Hollinger, Commander Richard Henline, Lt. Tom O'Neil, Lt. Suzanne Reading, Lt. Dineh Torres,  
and Clair McLean.**

**THE KELLY COMMUNIQUÉ IS A NON-PROFIT NEWSLETTER PUBLISHED AS A MEANS OF  
COMMUNICATION BETWEEN STAR TREK FANDOM.**

**IT DOES NOT INTEND TO INFRINGE UPON ANY RIGHTS.**

**'STAR TREK' IS A REGISTERED TRADEMARK OF PARAMOUNT PICTURES, CORP.**

**ALL RIGHTS ARE RESERVED TO ORIGINAL WORK HEREIN. NO COPYING WITHOUT THE  
PERMISSION OF THE PUBLISHER.**